



Chapter 10 VoIP for the Non-All-IP Mobile Networks

Associate Prof. Yuh-Shyan Chen
Department of CSIE
National Chung Cheng University
Mar. 2006



Outline

- 10.1 GSM-IP: VoIP Service for GSM 256
 - 10.1.1 MGCP Connection Model and the GSM-IP Architecture 259
 - 10.1.2 GSM-IP Message Flows 261
- 10.2 vGPRS: VoIP Service for GPRS 274
 - 10.2.1 Registration 277
 - 10.2.2 MS Call Origination 279
 - 10.2.3 MS Call Termination 281
 - 10.2.4 Intersystem Handoff 283
 - 10.2.5 Comparing vGPRS and 3GPP TR 21.978



Abstract

- **Chapter 10** describes how signaling protocols such as H.323 and **Media Gateway Control Protocol (MGCP)** are utilized in non-all-IP mobile networks to offer VoIP services.
 - We first introduce GSM-IP, a VoIP service for GSM.
 - A new MGCP package named GSM-IP is introduced, which supports media gateways connected to standard GSM BTSs.
 - Based on the signaling protocol translation mechanism in the MGCP signaling gateway, we describe how to interwork the MGCP elements with HLR, VLR, and MSC in the GSM network.
 - We present the message flows for registration, call origination, call delivery, call release, and inter-system handoff procedures for the GSM-IP service.



Cont.

- We show the feasibility of integrating GSM and the MGCP-based VoIP system without introducing any new MGCP protocol primitives.
- We describe vGPRS, a VoIP service for GPRS, which allows standard GSM and GPRS MSs to receive VoIP service.
 - In this approach, a new network element called the **VoIP Mobile Switching Center** is introduced to replace standard GSM MSC. The vGPRS approach is implemented by using standard H.323, GPRS, and GSM protocols. Thus, existing GPRS and H.323 network elements are not modified.
- We describe the message flows for vGPRS registration, call origination, call release, call termination, and intersystem handoff procedures.
- We also show that for international roaming, vGPRS can effectively eliminate tromboning (two international trunks in call setup) for an incoming call to a GSM roamer.



Introduction

- *Voice over IP (VoIP)* is a promising trend in the telecommunication business, and the momentum is clearly in favor of VoIP.
 - Industry analysts project that the number of residential VoIP subscribers in the U.S. will rise to about 12 million by 2009, and total U.S. revenue for business and residential VoIP products and services will be nearly \$21 billion US dollars
- VoIP services provide real-time and low-cost voice communications over the IP network.
 - Incorporating VoIP services into the existing telecommunication systems is essential.



Cont.

- The European Telecommunications Standards Institute's *Telecommunications and Internet Protocol TIPHON Harmonization over a Network ()* [ETS98a] specifies mechanisms to integrate IP telephony systems with *Switched Circuit Networks (SCN; e.g., GSM, PSTN, and ISDN)*.
 - Specifically, TIPHON defines several scenarios to illustrate different ways for integrating IP with mobile networks.
 - Systems such as *iGSM* (see Chapter 16 [Lin 01b]) and *GSM on the Net* [Gra98] have been proposed or implemented based on the TIPHON scenarios.
 - These systems utilize the ITU-T H.323 standard [ITU03] as the VoIP protocol.

Cont.



- This chapter describes how VoIP signaling protocols are utilized in the non-all-IP networks, specifically second-generation (2G) mobile networks (i.e., GSM and GPRS).
- *Media gateway control protocol (MGCP)* [And03] was proposed by Telcordia Technologies (formerly Bellcore) in 1998.

Cont.



- Based on the concept of **gateway decomposition**, MGCP assumes a call control architecture in which the call control “intelligence” is provided by call agents outside the telephony gateways.
- MGCP standardizes the interfaces between the telephony gateways and call agents.
- H.323, conversely, implements call control and call signaling conversion in the H.323 gateway.

10.1 GSM-IP: VoIP Service for GSM



- This section describes GSM-IP, a system that integrates GSM and MGCP based VoIP networks.
 - Our results can be easily modified to accommodate other protocols such as the IETF *Media Gateway Control (MEGACO)* protocol [Gro03].
 - Figure 10.1 illustrates an MGCP-based VoIP network.

Fig. 10.1 The MGCP-Based VoIP Architecture

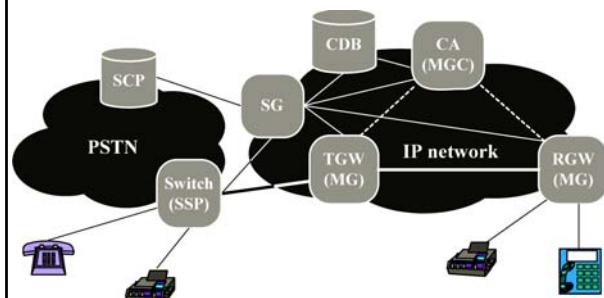

The network entities of GSM-IP



- **Media Gateway (MG)**
 - is a telephony gateway that provides conversion between the audio signals carried on the SCN and data packets carried over the IP network.
 - There are several MG types.
 - Two of them are used in GSM-IP:
 - *Residential Gateway (RGW)* and *Trunking Gateway (TGW)*.
 - The residential gateway provides a traditional analog interface, which connects existing analog telephones and fax machines to the VoIP network.
 - The trunking gateway interfaces between the PSTN and a VoIP network. A TGW is typically a **tandem** switch connecting to a switch in the PSTN via the T1 or E1 trunks.

Cont.



- **Signaling Gateway (SG)**
 - interworks the MGCP elements with the SS7 signaling network in the PSTN.
 - This gateway performs conversion between the SS7 signaling protocols such as SS7 *Transaction Capabilities Application Part (TCAP)* and *Integrated Services Digital Network User Part (ISUP)* in the PSTN and the IETF *Signaling Transport (SIGTRAN)* protocol in the IP network.
 - Details of SIGTRAN-based TCAP and ISUP are given in Chapter 8. The SG also maintains the **mapping** function between the SS7 and the IP addresses.
 - All MGCP elements communicating with the **SS7 Signaling Endpoints (SEPs)** follow the IETF **SIGTRAN** protocol shown in Figures 10.2 and 10.3. In these figures, an **SEP** can be a Service Switching Point (SSP), a Signal Transfer Point (STP), or a Service Control Point (SCP).

Fig. 10.2 ISUP-SIGTRAN Protocol

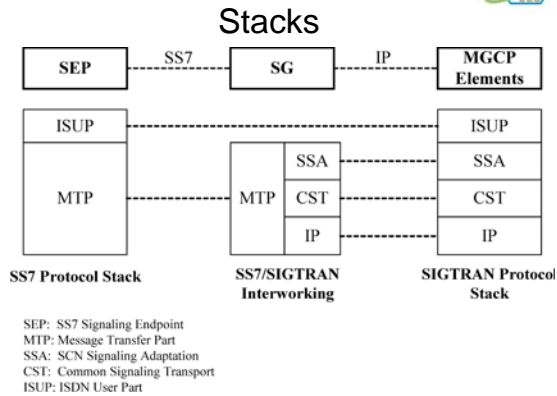
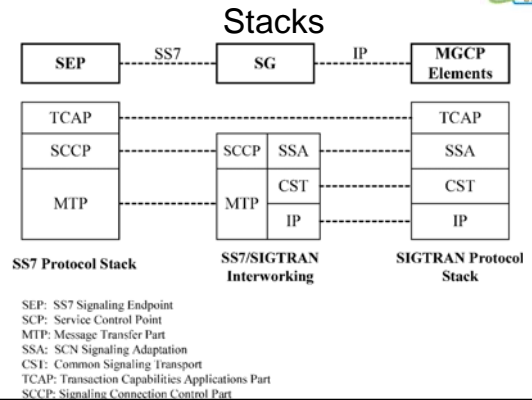

Fig 10.3 TCAP-SIGTRAN Protocol



Cont.

- The *SCN Signaling Adaptation (SSA)* layer supports specific primitives (e.g., address translation) required by a particular SCN signaling protocol such as ISDN or SS7.
 - In Chapter 8, the SSA for SS7 in this section is MTP3 User Adaptation Layer (M3UA).
- The *Common Signaling Transport (CST)* layer supports a common set of reliable functions for signaling transport.
- An example of CST is the *Stream Control Transmission Protocol (SCTP)*.
- The layer below CST utilizes the Internet Protocol (IP).
- Figure 10.2 illustrates the SIGTRANISUP protocol stacks and
- Figure 10.3 illustrates the SIGTRAN-TCAP protocol stacks [Lou04, Ong99].

Fig. 10.1 The MGCP-Based VoIP Architecture

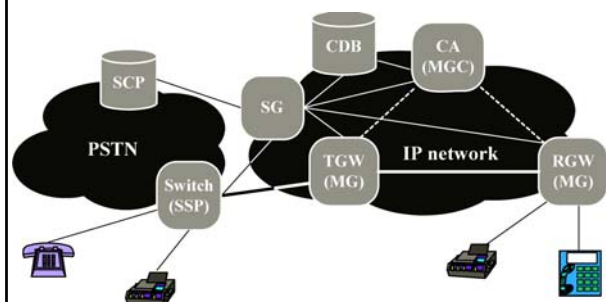

Cont.

- **Media Gateway Controller (MGC) or Call Agent (CA)**
 - is responsible for **call setup** and **release** of the media channels in an MG.
 - By utilizing the signaling protocol translation function in an SG, an MGC can handle the SS7 ISUP signaling for call setup between the IP network and PSTN.
 - By exchanging the SS7 TCAP messages, the MGC can also interact with the SCP over the SS7 network to provide *Intelligent Network (IN)* services.

Cont.

- **Common Database (CDB)**
 - serves as an IP SCP, directory server, and authentication center to perform authorization and routing functions.

10.1.1 MGCP Connection Model and the GSM-IP Architecture

- Based on the concept of endpoints and connections, the *MGCP connection model* establishes end-to-end voice paths.
- An endpoint at an MG serves as an interface of the data source or sink.
- The endpoint either terminates a trunk from a PSTN switch or terminates a connection from Customer Premises Equipment (CPE; e.g., telephone set, key telephone system, or private branch exchange).

10.1.2 GSM-IP Message Flows

- Figure 10.4 illustrates the GSM-IP architecture.
 - In this architecture, the GSM network is the same as that illustrated in Figure 2.1.
- Several MGCP elements are modified to perform additional functions for integrating the IP network with the GSM network.
 - In Figure 10.4, MG1 serves as a Mobile Switching Center (MSC) and BSC.

Fig. 2.1 GSM/GPRS/UMTS Network Architectures

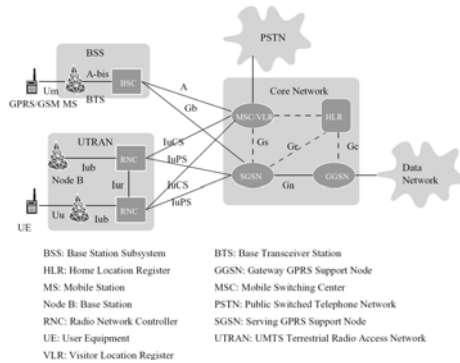
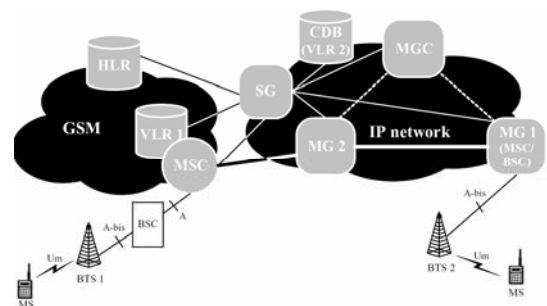

Fig. 10.4 The GSM-IP Architecture



Cont.

- The voice path is connected from the GSM to IP networks via a tandem gateway MG2.
- A GSM BTS connects to MG1 via the standard GSM A-bis interface.
- A CDB is used to implement a GSM VLR for GSM-IP subscribers who visit the IP network.
 - Every CDB is assigned an ISDN number that can be recognized by the HLR in the GSM network.
 - The CDB is responsible for performing GSM roaming management procedures based on GSM Mobile Application Part (MAP).

Cont.

- With the SIGTRAN (SCTP-based) protocol provided by the SG, the CDB communicates with the HLR and VLR in the GSM network as well as MG1 in the IP network.

Step 1.



- The MS periodically monitors the signal quality of the radio link and reports the signal strength to BSS1 via the **Um Measurement Report** message.

Fig. 10.11 Message Flow for GSM-IP Handoff

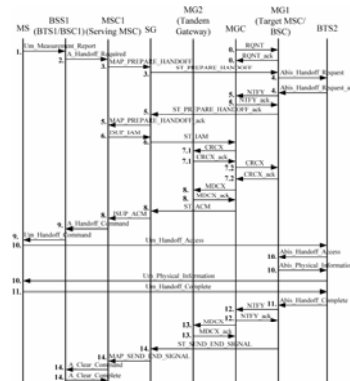

Step 2.



- Based on the measurement result sent from the MS, BSS1 recognizes that handoff is required.
- BSS1 requests MSC1 to perform the handoff procedure by issuing the **A Handoff Required** message.
- The A Handoff Required message contains a list of the target BTSs that are qualified to serve the MS.

Fig. 10.11 Message Flow for GSM-IP Handoff

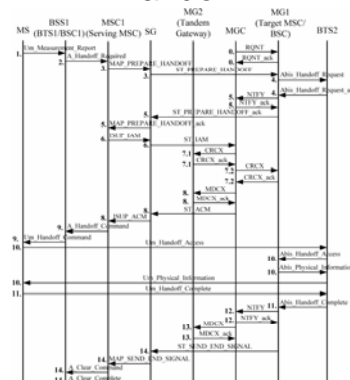

Step 3.



- After receiving the A Handoff Required message, MSC1 selects a **target BTS (BTS2)** for handoff.
- Since BTS2 is controlled by MG1 in the IP network, MSC1 sends the **MAP Prepare Handoff** message to MG1 via the **SG**.
- This message contains any information needed by MG1 to allocate a new radio channel for the MS.

Fig. 10.11 Message Flow for GSM-IP Handoff

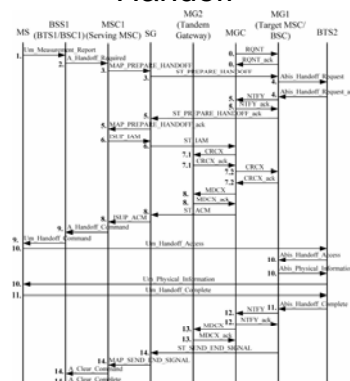
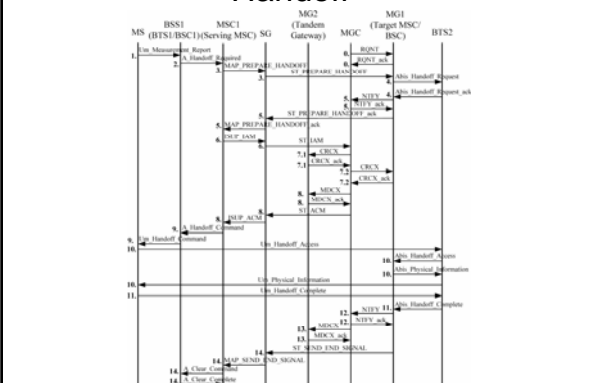

Fig. 10.11 Message Flow for GSM-IP Handoff



Step 7.

- After receiving the ST IAM message, the MGC starts the **voice path setup** procedure between **MG2** and **MG1**.
 - Step 7.1.** The MGC first sends the CRCX command to MG2 as described in Step 4.1 in Figure 10.7, which reserves the incoming trunk (i.e., the endpoint in MG2) connected to MSC1.
 - Step 7.2.** The MGC also sends the CRCX command to MG1 (the target MSC) along with the IP address and the UDP port of the endpoint in MG2. This step is similar to Step 4.2 in Figure 10.7, except that this CRCX command piggybacks a notification request, which asks MG1 to detect the Handoff Complete event, i.e., to detect whether the MS completes the handoff task.

Fig. 10.11 Message Flow for GSM-IP Handoff

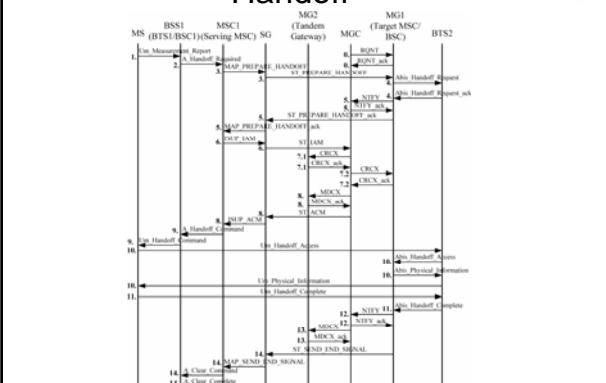

Step 8.

- The MGC sends the MDCX command to MG2.
- This command carries the connection information of the MG1 endpoint.
- The MGC also sends the **ST ACM** message to MSC1 via the **SG**.
 - This message indicates that the routing information required to set up the voice path has been received.

Fig. 10.11 Message Flow for GSM-IP Handoff

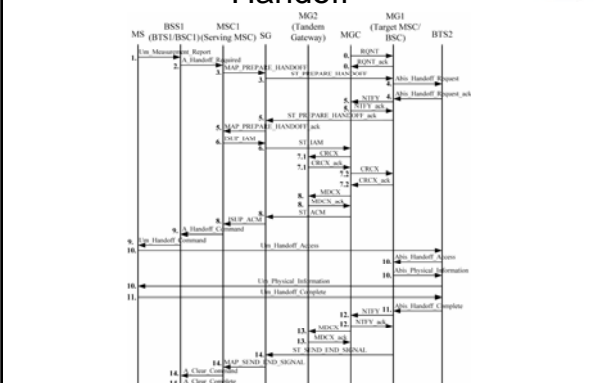

Step 9.

- After receiving the ISUP ACM message, MSC1 sends the **A Handoff Command** message to the MS through **BSS1**.
- This message instructs the MS to perform the handoff operation.
- This message includes the new radio channel identification supplied by BTS2.

Step 12.

- With the NTFY command, MG1 informs the MGC of the Handoff Complete event.

Fig. 10.10 Call Path for Inter-System Handoff

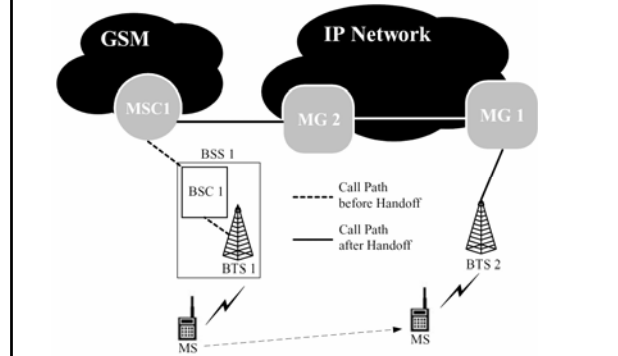
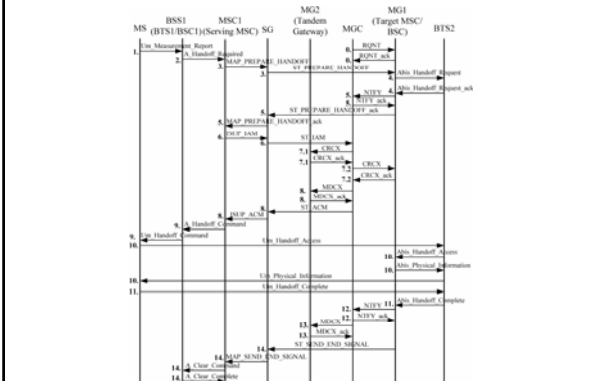

Fig. 10.11 Message Flow for GSM-IP Handoff



Step 13.

- The MGC instructs MG2 to change the connection mode of the MG1 endpoint to “send/receive” by issuing the MDCX command.

Fig. 10.11 Message Flow for GSM-IP Handoff

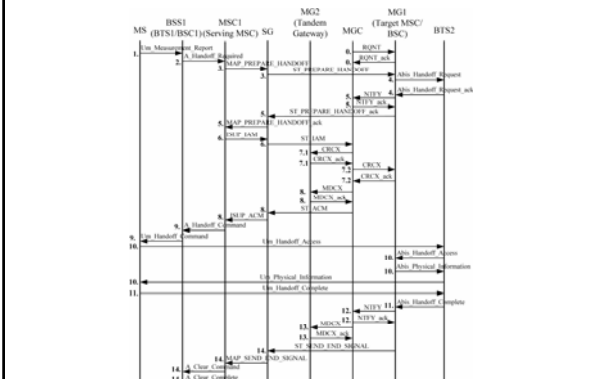

Step 14.

- At this point, the handoff procedure is complete and the MS is switched to the new call path.
- MG1 sends the **ST Send End Signal** message to MSC1 through the SG.
 - This message indicates that the new radio path of the MS has been connected.
 - Upon receipt of the MAP Send End Signal message, MSC1 instructs BSS1 to clear the radio resource with the A Clear Command message.
 - Then BSS1 releases the radio channel of the MS and returns the A Clear Complete message to MSC1.

10.2 vGPRS: VoIP Service for GPRS

- This section describes vGPRS, a VoIP mechanism for GPRS.
 - The vGPRS approach is implemented using standard H.323, GPRS, and GSM protocols.
 - Thus, existing GPRS and H.323 network elements are not modified.
- The vGPRS approach provides VoIP service to standard GSM and GPRS MSs.
- In vGPRS, a new network node called **VoIP MSC (VMSC)** is introduced to replace MSC.

Cont.

- The VMSC is a router-based softswitch and its cost is anticipated to be cheaper than an MSC.
- Figure 10.12 (a)** shows the interfaces between the VMSC and other GSM/GPRS network nodes.
 - The GSM signaling interfaces of the VMSC are exactly the same as that of an MSC.
 - That is, it communicates with the BSC, the VLR, and the PSTN through the A interface, the B interface (the interface between MSC and VLR), and SS7 ISUP, respectively.

Fig. 10.12 The VMSC Interfaces and the VGPRS Network Architecture

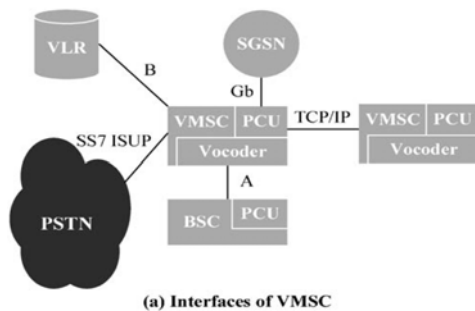
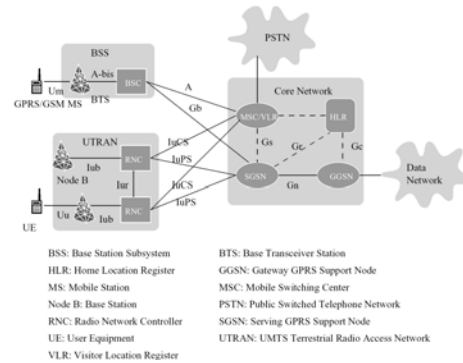

Fig. 2.1 GSM/GPRS/UMTS Network Architectures



Cont.

- Unlike an MSC, the VMSC communicates with Serving GPRS Support Node (SGSN) through the GPRS **Gb** interface.
- In other words, while an MSC delivers voice traffic through circuit-switched trunks, the VMSC delivers VoIP packets through the GPRS network.
 - In **Figure 10.12 (b)**, an SGSN receives and transmits packets between the MSs and their counterparts in the packet data network.

Fig. 10.12 The VMSC Interfaces and the VGPRS Network Architecture

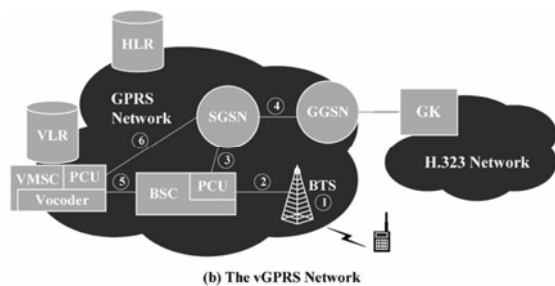

Cont.



- To connect to an SGSN, a *Packet Control Unit (PCU)* is implemented in the BSC.
- The BSC forwards circuit-switched calls to the MSC, and packet-switched data (through the PCU) to the SGSN.
- A BSC can only connect to one SGSN.
- The data path of a GPRS MS is (1)↔(2)↔(3)↔(4).
- The voice path is (1)↔(2)↔(5)↔(6)↔(4).
 - In this voice path, (1)↔(2)↔(5) is circuit-switched as in GSM.

Cont.



- Thus, both standard GSM MSs and GPRS MSs can set up calls as if they were in the standard GSM/GPRS network.
- At the VMSC, the voice information is translated into GPRS packets through the vocoder and the PCU.
- Then the packets are delivered to the GPRS network through the SGSN.
- See path (6)↔(4).

Cont.



- An IP address is associated with every MS attached to the VMSC.
- In GPRS, the IP address can be created statically or dynamically for a GPRS MS.
- A standard GSM MS cannot be assigned an IP address through GPRS.
- In vGPRS the creation of the IP address is performed by the VMSC through the standard **GPRS Packet Data Protocol (PDP)** context activation procedure.

Cont.



- The VMSC maintains an MS table. This table stores the MS mobility management (MM) and PDP contexts such as TMSI, IMSI, and the QoS profile requested.
- These contexts are the same as those stored in a GPRS MS (see Chapter 2). In vGPRS, the H.323 protocol is used to support voice applications.
- The VMSC executes the H.323 protocol just like an H.323 terminal.
 - To support inter-system handoff, VMSCs communicate with each other using TCP/IP (see Section 10.2.4).
 - The vGPRS can also be implemented by using *Session Initiation Protocol (SIP)*; see Chapter 12).

Fig. 10.13 Connection between an H.323 Terminal and a GSM MS

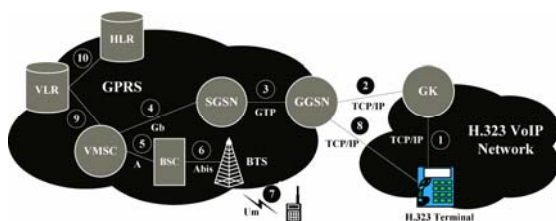

Cont.



- A *gatekeeper (GK)* in the H.323 network (see Figure 10.12 (b)) performs standard H.323 gatekeeper functions (such as address translation).
- Figure 10.13 illustrates the connection between an H.323 terminal and a GSM MS.
 - In this figure, the TCP/IP protocols are exercised in links (1), (2), and (8).
- The *GPRS Tunneling Protocol (GTP)* is exercised in link (3), and the GPRS Gb protocol [ETS97b] is exercised in link (4). The standard GSM protocols are exercised in links (5), (6), (7), (9), and (10).

Cont.



- The H.323 protocol is implemented on top of TCP/IP, and is exercised between the VMSC and the H.323 nodes in the IP network.
 - The H.323 packets are encapsulated and delivered in the GPRS network through the GTP.
- The vGPRS procedures utilize the *Registration, Admission, and Status (RAS)* and Q.931 messages as defined in the H.323 and H.225 protocols [ITU03, ITU98].
 - These procedures also involve the Um, A, A-bis, and MAP interfaces/protocols.
- In GSM, a registration procedure is performed when an MS is turned on or when the MS moves to a new location area.

10.2.1 Registration



- Without loss of generality, this section describes the registration procedure by assuming that registration is performed when the MS is turned on. The registration procedure for MS movement is similar and is briefly elaborated at the end of this section.
- The GSM registration messages (Steps 1.1, 1.2, and 1.3 below) are delivered through the path (7) ↔ (6) ↔ (5) ↔ (9) ↔ (10) in Figure 10.13.
- The H.323 messages (Steps 1.4, 1.5, and 1.6 below) are delivered through the path (7) ↔ (6) ↔ (5) ↔ (4) ↔ (3) ↔ (2).

Fig. 10.13 Connection between an H.323 Terminal and a GSM MS

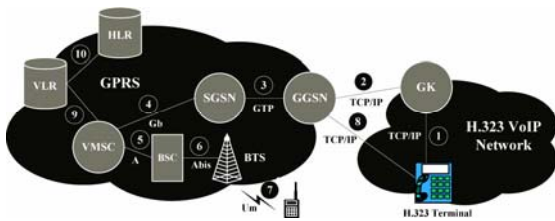
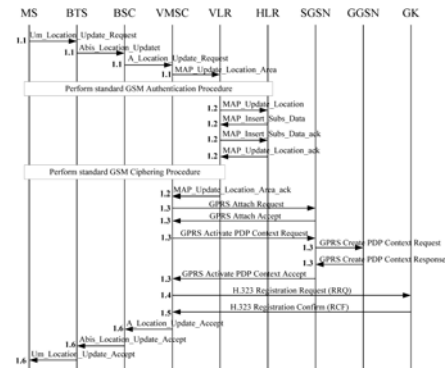

Fig. 10.14 Message Flow for vGPRS Registration



10.2.2 MS Call Origination



- This section describes MS call origination in which the MS is the calling party. The called party can be another MS in the same GPRS network or an H.323 terminal in the H.323 VoIP network.
- The called party can also be a traditional telephone set in the PSTN, which is connected indirectly to the GPRS network through the H.323 network. Without loss of generality, we assume that the called party is an H.323 terminal user.

Fig. 10.15 The Message Flows for MS Call Origination and Call Release

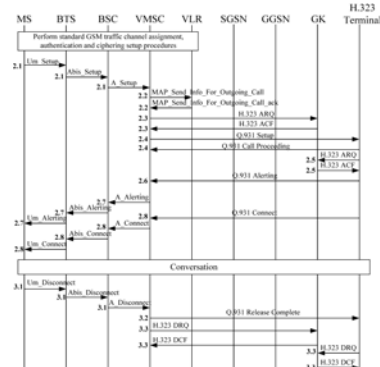

10.2.3 MS Call Termination

- This section describes the message flow for the MS call termination.
- We assume that the call originated from an H.323 terminal, and that the MS is the called party.

Fig. 10.16 Message Flow for MS Call Termination

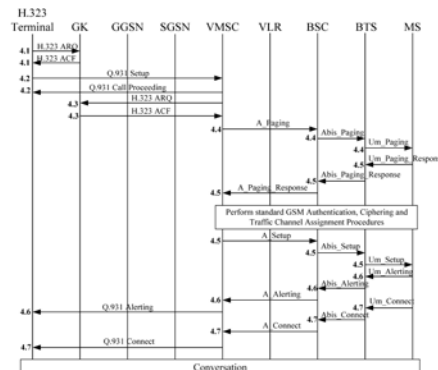

10.2.4 Inter-System Handoff

- This section describes inter-system handoff for vGPRS.
- We assume that the serving VMSC (old VMSC) and the target VMSC (new VMSC) are connected to different SGSNs (see Figure 10.17). In this figure, Path (1)↔(2) is the routing path before the handoff, and Path (1)↔(3) is the routing path after the handoff.

Fig. 10.17 The Routing Path before and after Inter-System Handoff

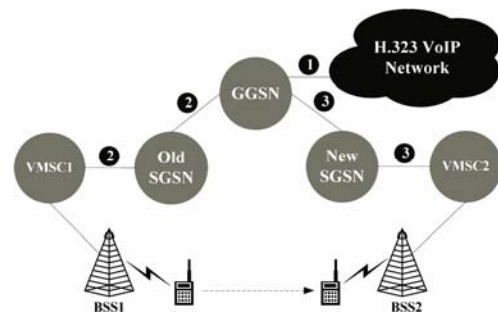

Fig. 10.18 The Message Flow for Inter-System Handoff

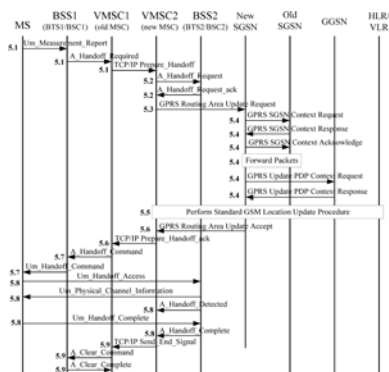

Fig. 10.19 Tromboning Phenomenon in GSM

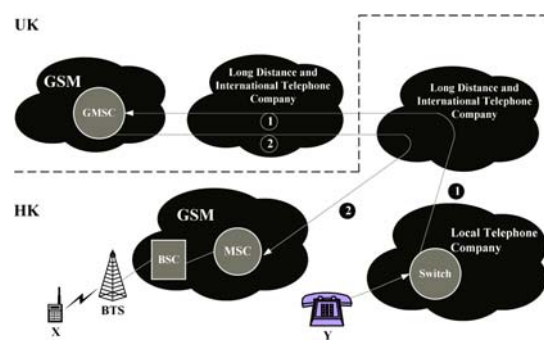
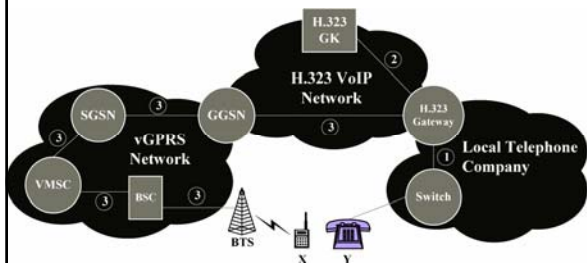

Fig. 10.20 Tromboning Elimination in vGPRS



Homeworks

- **Homework 10-1:** Show how short message service (SMS) can be implemented in GSM-IP. (See Chapter 1 for details of SMS.)
- **Homework 10-2:** Draw the vGPRS location update message flow when the MS movement involves the crossing of two SGSNs.